

# Lumen Tech

Lighting, LLC.

## Design SC8 Storm 8 Series Wall Sconce

Maximum 175W Metal Halide  
150W High Pressure Sodium  
Or 2-42W PLT Compact Fluorescent

### Specifications

**Housing:** Heavy duty cast aluminum with quick mount system. Powder coated finish. See finish note.

**Lens:** Clear tempered glass silicone sealed to door frame. Door frame gasketed to housing and secured with stainless steel captive tamper proof screws.

**Reflector:** Anodized aluminum, computer designed for efficiency, **classified full cut-off dark sky compliant**. Adjustable for type II, type III or type IV distribution.

**Ballast:** **H.I.D.:** Pre-wired C.W.A., H.P.F. core and coil with capacitor. **CF:** Compact fluorescent electronic high power factor class P, universal voltage 120 thru 277 volt; 50/60 Hz.

**Lamp:** **H.I.D.:** Clear medium base. **CF:** PLT lamp, 4 pin base (by others).

**Lamp Holder:** **H.I.D.:** High heat 4 K.V. rated, w/nickel plated copper screw shell, spring loaded center contact.

**CF:** White thermoplastic with snap-in lamp retainer springs.

**Finish:** Bronze, detergent cleaned, prime coated chip resistant powder urethane polyester coating. Contact factory for other colors.

**Photometric Information:** Contact factory.

**Labels:** U/L, CUL listed suitable for wet location.

*SPECIFICATIONS SUBJECT TO CHANGE WITHOUT NOTICE*

### Ordering Information

Catalog Number	Watts	Light Source
SC8T26	26	Compact Fluorescent
SC8T32	32	Compact Fluorescent
SC8T42	42	Compact Fluorescent
SC82T26	2-26	Compact Fluorescent
SC82T32	2-32	Compact Fluorescent
SC82T42	2-42	Compact Fluorescent
SC850H	50	HPS
SC870H	70	HPS
SC8100H	100	HPS
SC8150H	150	HPS
SC850M	50	MH
SC870M	70	MH
SC8100M	100	MH
SC8150M	150	MH
SC8175M	175	MH



**DARK SKY  
COMPLIANT  
IES FULL CUTOFF**

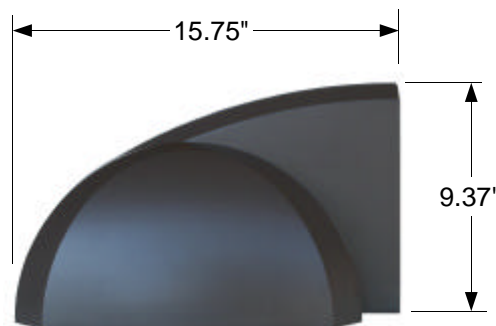

## Mounting System



**Storm 8 Quick Mount System**



Mounting bracket & bubble level device.



1. Level bracket and install on wall.



2. Hook fixture housing to mounting bracket.



3. Tighten the mounting bracket to the fixture from the inside.



4. Close the door frame and secure the door frame screws.

## Photometric Information

150W Metal halide clear ED17 lamp.  
 12,600 Lumens.  
 1.0 LLF  
 10' Mounting Height  
 Grid lines equal 1 mounting height.  
 Clear tempered flat glass lens.

5 Position adjustable reflector tilt puts the light where it's needed.

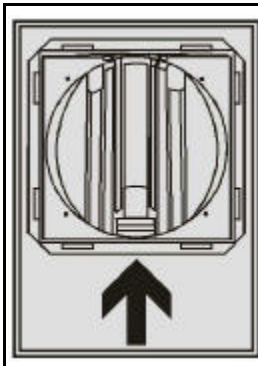
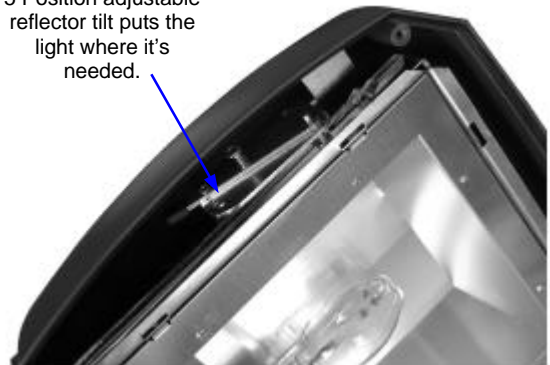

Reflector rotation at 0°.

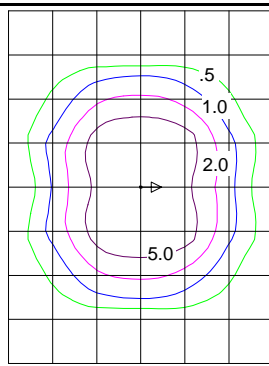

Type II distribution wide throw.

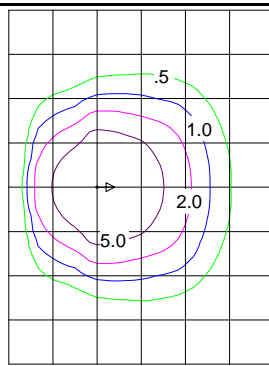

Type III distribution wide throw.

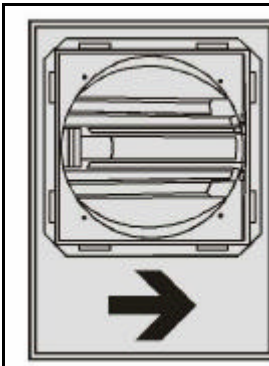

Reflector rotation at 90°.

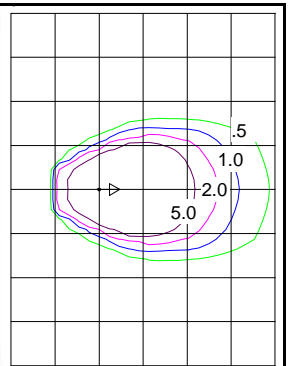

Type IV distribution forward throw.